

BTC-miniB

(DisplayPort, HDMI and RGB TFT-LCD Controller)

Product Specification

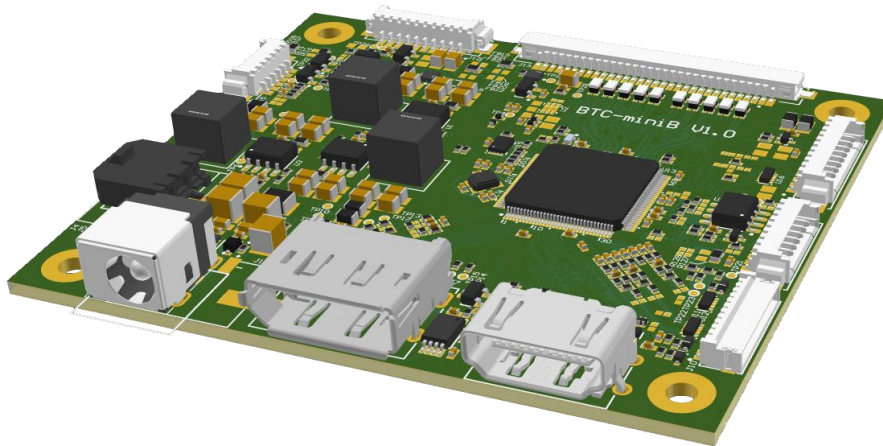

Product Specification Status

- Preliminary
- Final

This specification is subject to legal disclaimers.

1. Product Overview

This DisplayPort, HDMI and analog RGB to LVDS converter board accepts common video signals. DisplayPort 1.2 HDMI 1.4a and all backward compatible signals are supported as well as analog RGB. It generates all necessary control signals and panel data to drive TFT-LCDs with VDD levels 3.3V, 5V or 12V. This TFT-controller board supports resolutions up to 1920x1200 (WUXGA) at a vertical refresh rate up to 60Hz. The user interface includes backlight, brightness, contrast, etc. adjustment by on-screen programming. For automatic backlight adjustment an ambient light sensor is supported. Several OSD functions can be managed via embedded I²C-interface or DDC/CI.

This board is available in different assembly configurations.

2. Features

General

- Support up to 1920x1200 (WUXGA) resolution @ 60Hz
- DDC/CI support by embedded DDC I²C-bus interface
- I²C-slave interface for display control
- Panel usage timer
- On-board status LED

Power Management

- Input voltage from 12V or 24V-32V
- Reverse voltage protection
- TFT panel power supply of 3.3V, 5V or 12V
- Backlight power supply 5V, 12V or 24V

DisplayPort 1.2 Digital Input Interface

- High-Bandwidth Digital Content Protection (HDCP v1.4) support
- Supports 6-bit, 8-bit, 10-bit, and 12-bit color depth transport

HDMI 1.4a Compliant Digital Input Interface

- Single link on-chip TMDS receiver up to 225MHz
- High-Bandwidth Digital Content Protection (HDCP v1.4) support
- Supports DVI 1.0

Analog RGB Input Interface

- Supports Sync-On-Green (SOG) and various kinds of composite sync modes
- YPbPr support up to 1080p

Auto Detection / Calibration

- Input format detection
- Compatibility with standard VESA Mode
- Smart engine for phase / image position / color calibration

Scaling

- Fully programmable zoom ratios
- Independent horizontal/vertical scaling
- Advanced zoom algorithm provides high image quality
- Sharpness/Smooth filter enhancement
- Support non-linear scaling from 4:3 to 16:9 or 16:9 to 4:3

Color Processor

- True 10-bit color processing engine
- sRGB compliance

Output Interface

- Dual-LVDS 24-bit output interface
- Spread-Spectrum DPLL to reduce EMI

- Support VESA and JEIDA mapping

On Screen Display menu

- Backlight dimming
- Color adjustments
- Several other settings

Audio

- I²S 8-channel support
- Embedded Audio DAC

Environmental

- ✓RoHS
- ✓REACH

3. Functional Diagram

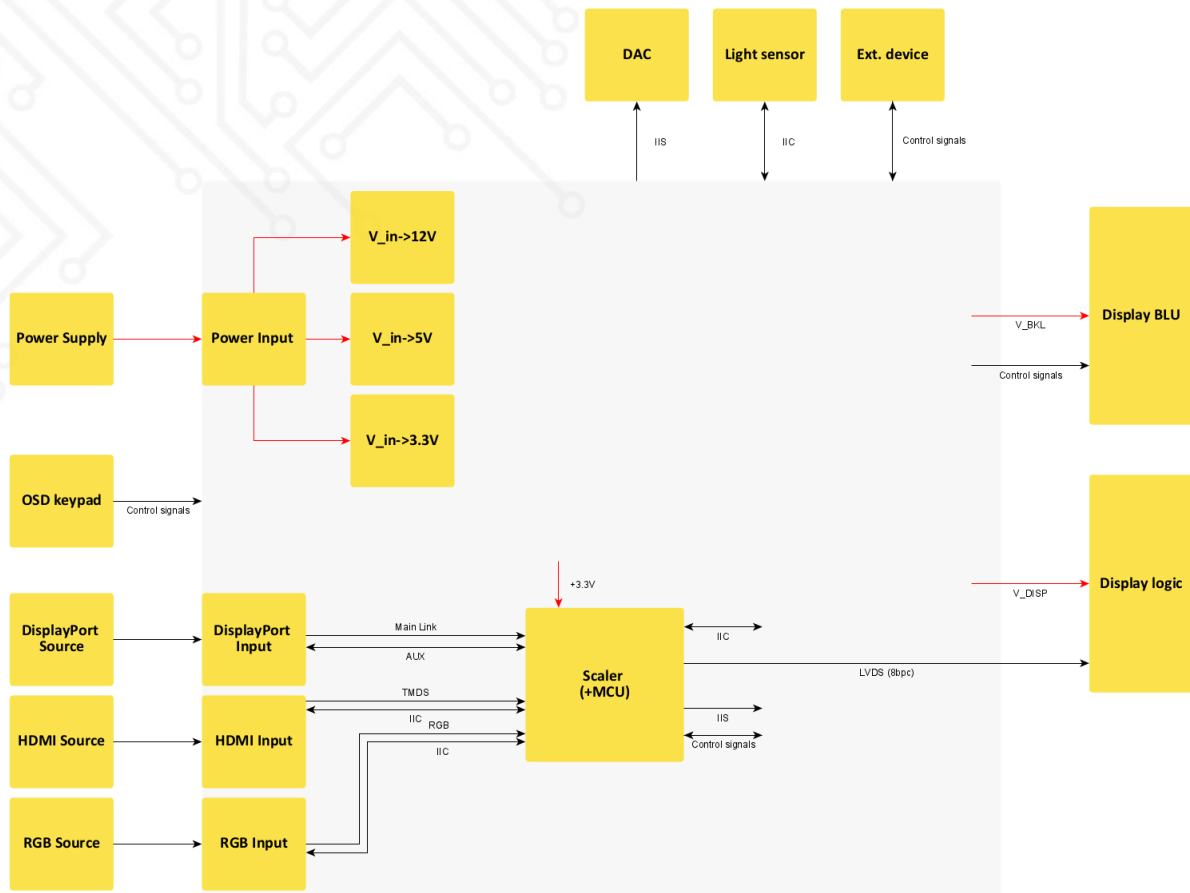

Fig 1. System Diagram

4. Typical Application

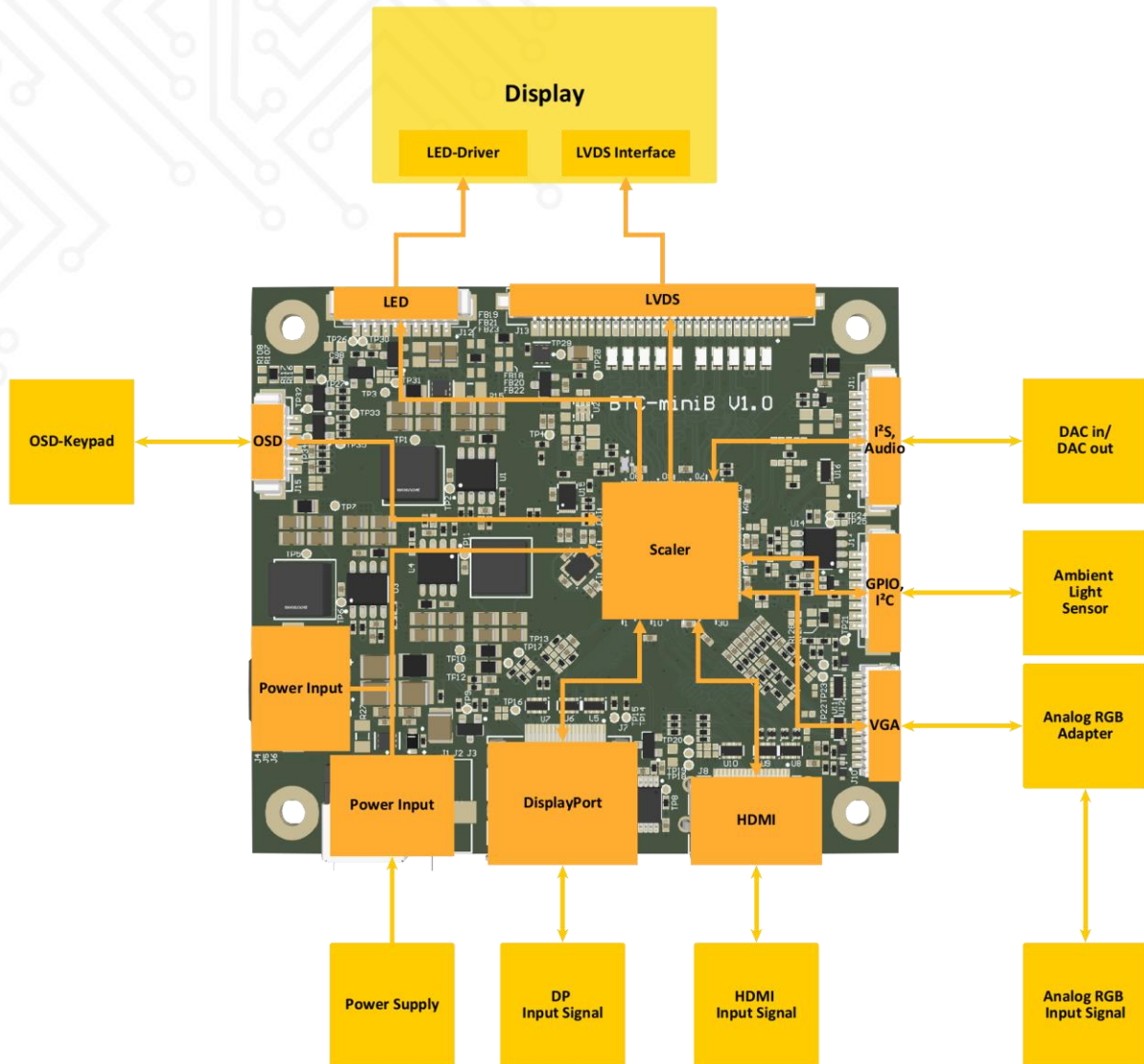

Fig 2. Application of BTC-miniB

5. Electrical Characteristics

All ratings @ $V_{DD} = 12.0V$, $\theta = 25^{\circ}C$, Var. STD, and voltages referenced to GND, unless otherwise noted.

a. Input

Table 1. Electrical Input Characteristics

Symbol	Parameter	Test conditions	Min	Typ	Max	Unit
V_{DD}	Operating Supply Voltage ¹	Var. STD	11.4	12.0	12.6	V DC
		Var. STD	16.0	24.0	32.0	V DC
		Var. Lite-12V	10.8	12.0	13.2	V DC
		Var. Lite-24V	16.0	24.0	32.0	V DC
V_{DDmax}	Absolute Max. Rating ²	Var. STD	-36.0	-	36.0	V DC
		Var. Lite-12V	-0.3	-	38.0	V DC
		Var. Lite-24V	-0.3	-	38.0	V DC
I_{DD}	Current Consumption ³	Board Only (active mode)	49	62	98	mA
		Board Only (sleep mode)	10	10	10	mA
		With WVGA Display ⁴	0.12	0.22	0.32	A
		With XGA Display ⁵	0.25	0.55	0.88	A
		With FHD Display ⁶	0.33	0.60	0.85	A
P_{DD}	Power Consumption	Sleep mode	0.12	0.12	0.12	W
		Active mode	0.59	0.75	1.18	W

b. Output

DC Characteristics

Table 2. Electrical Output Characteristics

Symbol	Parameter	Test conditions	Min	Typ	Max	Unit
V_{Panel}	Display Supply Voltage	3.3V configuration	3.0	3.3	3.6	V DC
		5V configuration	4.5	5	5.5	V DC

¹ In Var. STD: Ensure to be in one of the two ranges.

² Consider ratings of connected parts

³ Current consumption depends on the board's variant & firmware

⁴ Test was performed with InnoLux G070Y2-L01 Rev. C6 (WVGA, 500cd/m²). Backlight PWM duty ratio min: 10%

⁵ Test was performed with InnoLux G150XNE-L01 (XGA, 500cd/m²). Backlight PWM duty ratio min: 5%

⁶ Test was performed with AUO G215HVN01.0 (FHD, 300cd/m²). Backlight PWM duty ratio min: 10%

		12V configuration	10.8	12	13.2	V DC
I_{Panel}	Display Supply Current	-	-	-	2.5	A
V_{BKL}	Backlight Supply Voltage	5V configuration	4.5	5	5.5	V DC
		12V configuration	10.8	12	13.2	V DC
		V_{DD} configuration	-	V_{DD}	-	V DC
I_{BKL}	Backlight Supply Current	V_{DD} configuration	-	-	3	A
V_{BKL_EN}	Backlight Enable Voltage	3.3V configuration	3.0	3.3	3.6	V DC
		5V configuration	4.5	5	5.5	V DC
V_{BKL_ADJ}	Backlight Adjust Voltage	3.3V configuration	3.0	3.3	3.6	V DC
		5V configuration	4.5	5	5.5	V DC
$f_{BKL_ADJ}^7$	Backlight Adjust Frequency	PWM configuration	160	200	20k	Hz
D_{BKL_ADJ}	Backlight Adjust Duty Cycle	PWM configuration	0	-	100	%

Panel Power Sequencing

BTC-miniB follows a special sequence to power up display- and backlight-VCC. This timing is set in the F/W.

6. OSD (On-Screen Display)

The user-friendly, intuitive controllable integrated OSD menu provides certain functions to change settings, adjust the image and others. It can be controlled by an OSD-keyboard. The status of the LCD controller can be checked by a LED which is integrated on the keyboard.

a. OSD-Keyboard

A 5-button OSD-keyboard with one LED on it to show the board's status is connectable.

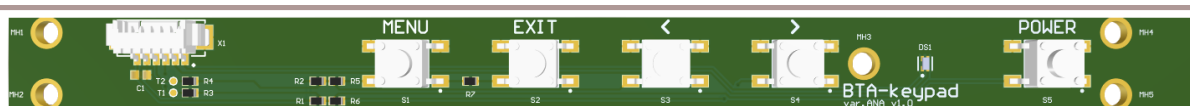

Fig 3. OSD-keyboard

Buttons

The function of each OSD key is shown in the following table.

Table 3. OSD keyboard functions

No.	Button	Switch Function	Hot-Key Function
1	Menu	1. Open OSD sub menu 2. Save changes and exit	Open OSD main menu

⁷ Analog inverse output by hardware configuration.

2	Exit	Discard changes and exit	-
3	Left	1. Move left in menu list 2. Decrease the value of selected item	Show signal info
4	Right	1. Move right in menu list 2. Increase the value of selected item	Input select
5	Power	Turn power on / off	-

LED

LED colors and their meanings are described in the table below.

Table 4. OSD-keyboard LED status lights

LED Color	Status	Represents
Green	Constant	Normal state
Amber	Constant	Searching signal
Red	Constant	Power saving

b. OSD-menu

Menu Structure

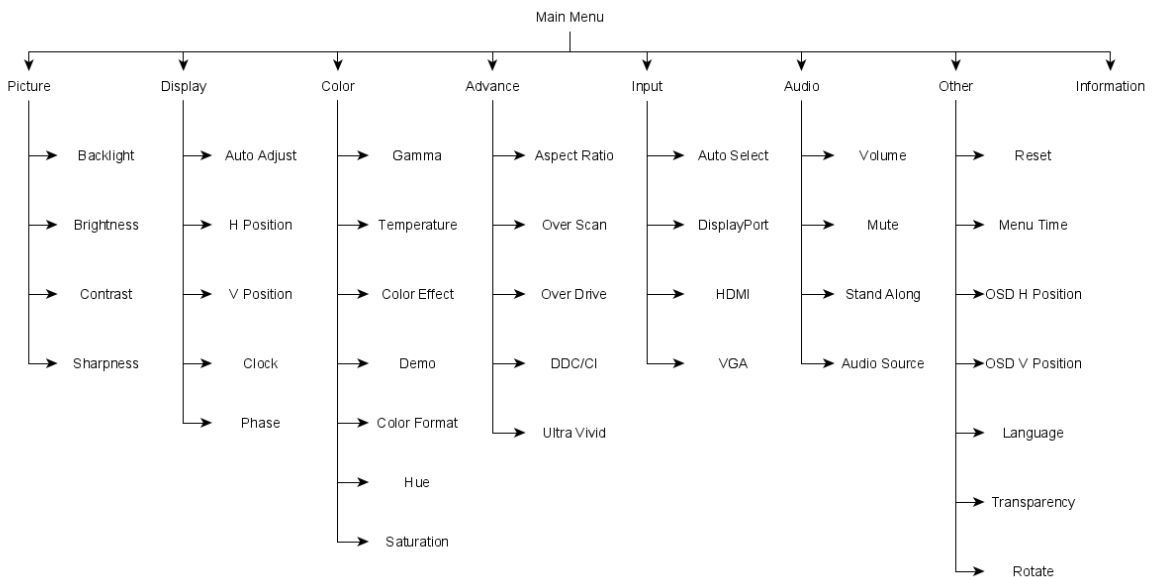

Fig 4. OSD-menu structure

Menu Items

Table 5. OSD: Menu Items

Title	Function
Picture	Adjust image settings
Display	Adjust image position
Color	Adjust color settings
Advance	Advanced settings
Input	Input source selection
Audio	Audio settings
Other	Adjust the On-Screen-Display settings
Information	Information about current timing

Main-Menu: Picture

Table 6. OSD: Main-Menu Picture

Title	Function
Backlight	Adjust the backlight-intensity
Brightness	Adjust the brightness of the image
Contrast	Adjust the contrast of the image
Sharpness	Adjust the sharpness of the image

Main-Menu: Display⁸

Table 7. OSD: Main-Menu Display

Title	Function
Auto Adjust	Input format detection, phase/image position adjustment
H Position	Adjust horizontal position of the image
V Position	Adjust vertical position of the image
Clock	Adjust clock
Phase	Adjust phase

Main-Menu: Color

Table 8. OSD: Main-Menu Color

Title	Function
Gamma	Adjust gamma level of the image
Temperature	Adjust the color temperature
Color Effect	Select a color effect
Demo	Select a mode to check hue and saturation settings
Color Format	Select the color model
Hue	Adjust the color balance
Saturation	Adjust the color intensity

Sub-Menu: Temperature - User

Table 9. OSD: Sub-Menu: Temperature - User

Title	Function
R	Adjust red video gain
G	Adjust green video gain
B	Adjust blue video gain

⁸ Available for analog RGB

Sub-Menu: Color Effect - User

Table 10. OSD: Sub-Menu: Color Effect - User

Title	Function
Hue	Adjust hue of respective 6-axis color
Saturation	Adjust saturation of respective 6-axis color

Main-Menu: Advance

Table 11. OSD: Main-Menu Advance

Title	Function
Aspect Ratio	Select aspect ratio or scaling factor of the image
Over Scan	Enable / Disable overscan function
Over Drive	Enable / Disable overdrive function
DDC/CI	Enable / Disable DDC/CI function
Ultra Vivid	Select grades of Ultra Vivid color mode

Main-Menu: Input

Table 12. OSD: Main-Menu Input

Title	Function
Auto Select	Select first available input signal
DisplayPort	DisplayPort fixed
HDMI	HDMI fixed
RGB	RGB fixed

Main-Menu: Audio⁹

Table 13. OSD: Main-Menu Audio

Title	Function
Volume	Adjust audio volume

Mute	Mute audio output
Stand Along	Enable / Disable standby audio
Audio Source	Select audio source

Main-Menu: Other

Table 14. OSD: Main-Menu Other

Title	Function
Reset	Reset all OSD settings
Menu Time	Set the OSD duration [s]
OSD Position H	Set the horizontal position of OSD menu
OSD Position V	Set the vertical position of OSD menu
Language	Select OSD menu language
Transparency	Adjust the transparency of the OSD menu
Rotate	Rotate OSD by 0°, 90° or 270°

Main-Menu: Information

Table 15. OSD: Main-Menu Information

Title	Function
Signal source	Show current signal source
Current resolution	Show resolution of input signal
H- & V-frequency	Show horizontal and vertical frequency
Pixel clock frequency	Show pixel clock frequency
Board model	Board model
Firmware name	Firmware name
Firmware version	Firmware version

⁹ Only for analog audio output.

7. Interfaces

a. LVDS Interface

At the LVDS-Interface, single- and dual-channel LVDS is supported in either 6- or 8-bit configuration. As the board is delivered pre-configured, no changes have to be made to the settings. Pixel clocks up to 93MHz in single-channel LVDS and 186MHz in dual-channel LVDS configuration, and therefore resolutions up to WUXGA (1920x1200) @ 60Hz are supported.

Settings

In order to achieve reliable communication when using longer cables, pre-emphasis may be applied to the LVDS signal lines. On the other hand, the spread spectrum function can enhance the behavior in an EMI sensitive environment.

Mapping

6-bit and 8-bit per color (18-bit or 24-bit color depth) VESA- and JEIDA-mappings are supported at the LVDS-interface. The bit numbering of pixels is big endian, where the most significant bit has the largest bit number.

Table 16. LVDS Bit Number Mappings

VESA		JEIDA	
6-bit	8-bit	6-bit	8-bit
5	7	5	5
4	6	4	4
3	5	3	3
2	4	2	2
1	3	1	1
0	2	0	0
	1		7
	0		6

The following tables are identical for odd and even lines.

Table 17. VESA Data Packing

LVDS Data Line	Bit position						
	6	5	4	3	2	1	0
D 0	G0	R5	R4	R3	R2	R1	R0
D 1	B1	B0	G5	G4	G3	G2	G1
D 2	DE	VS	HS	B5	B4	B3	B2
D 3 (for 8-bit)	-	B7	B6	G7	G6	R7	R6

Table 18. JEIDA Data Packing

LVDS Data Line	Bit position						
	6	5	4	3	2	1	0
D 0	G2	R7	R6	R5	R4	R3	R2
D 1	B3	B2	G7	G6	G5	G4	G3
D 2	DE	VS	HS	B7	B6	B5	B4
D 3 (for 8-bit)	-	B1	B0	G1	G0	R1	R0

b. I²C Interface

BTC-miniB can control various slave devices via a general purpose I²C-bus interface. Also BTC-miniB can act as slave device and receive display configuration settings. For further information about I²C usage, please contact your local sales partner.

Ambient Light Sensor

BTC-miniB can control an ambient light sensor via an I²C-bus or SMBus interface. Various light sensors are supported which are Plug & Play ready (e.g. TI OPT3001) and therefore do not require additional modifications.

Audio Amplifier

BTC-miniB can control an external audio amplifier with I²C-bus or SMBus interface connected to the Audio Connector (J11).

Electrical Characteristics

DC Characteristics

Table 19. I²C Interface DC Characteristics

Symbol	Characteristic	Test conditions	Min	Typ	Max	Unit
V _{CC}	I ² C-bus operating voltage (internal pull-up)	3.3V configuration	3.0	3.3	3.6	V
V _{IH}	High-level input voltage	-	0.7 V _{CC}	-	-	V
V _{IL}	Low-Level input voltage	-	-	-	0.3V _{CC}	V

AC Characteristics

Table 20. I²C Interface AC Characteristics

Symbol	Characteristic	Min	Typ	Max	Unit
f _{CLK}	Clock Frequency	-	100	400	kHz
t _{HIGH}	Clock high time	600	-	-	ns
t _{LOW}	Clock low time	1300	-	-	ns

Operations

In general, the I²C-bus operations must follow the I²C-bus standard.

Write

A write operation looks the following way:

Start	Device Address	Write	Ack	Word Address	Ack	Data	Ack	Stop
-------	----------------	-------	-----	--------------	-----	------	-----	------

Read

A random read operation looks the following way:

Start	Device Address	Write	Ack	Word Address(n)	Ack	Start	Device Address	Read	Ack	Data(n)	No Ack	Stop
-------	----------------	-------	-----	-----------------	-----	-------	----------------	------	-----	---------	--------	------

c. I²S Interface

BTC-miniB has an I²S interface to handle and forward audio data. This 3-line serial bus consisting of a line for two time-multiplexed data channels (SD), a word select line (WS) and a clock line (SCK), follows the I²S-bus specification.

This controller can only act as master and generates the bit clock, word-select signal, and data.

Sampling frequencies of 32kHz to 192kHz are supported.

d. DDC

This LCD controller provides a serial communications link between the video adapter and the controller, the DDC (Display Data Channel). Properties such as maximum resolution, color depth and supported video timing modes can be transmitted using DDC.

EDID

The BTC-miniB controller board supports the Extended Display Identification Data (EDID 1.4) standard.

EDID contains basic information about a monitor and its capabilities, including vendor information, maximum image size, color characteristics, factory pre-set timings, frequency range limits, a character's string for the monitor name and serial number. The video adapter uses this information for configuration purposes, so that the monitor and system can work together.

DDC/CI

The display controller complies with the MCCS 2.2a standard. It supports a standard set of MCCS VCP codes to adjust the displayed image or control the display. Read and write commands are available for the following categories:

- Image Adjustments
- Color Adjustments
- Image Geometry Adjustments
- Audio Adjustments
- Window Operations
- DPVL Support

8. Mechanical Characteristics

2D- (e.g. DXF) & 3D- (e.g. STEP) files for easy product design-in available.

Table 21. Mechanical Characteristics

Parameter	Value
Dimensions (H x V)	80.0mm x 70.0mm
Total height (Var. STD)	9.8mm (Top: 7.3mm, PCB: 1.6mm, Bot: 0.9mm)
Contour	Rectangular
Production technology	SMT / THT
Mounting holes	3.2mm (Use M3 screws)
Weight	36g

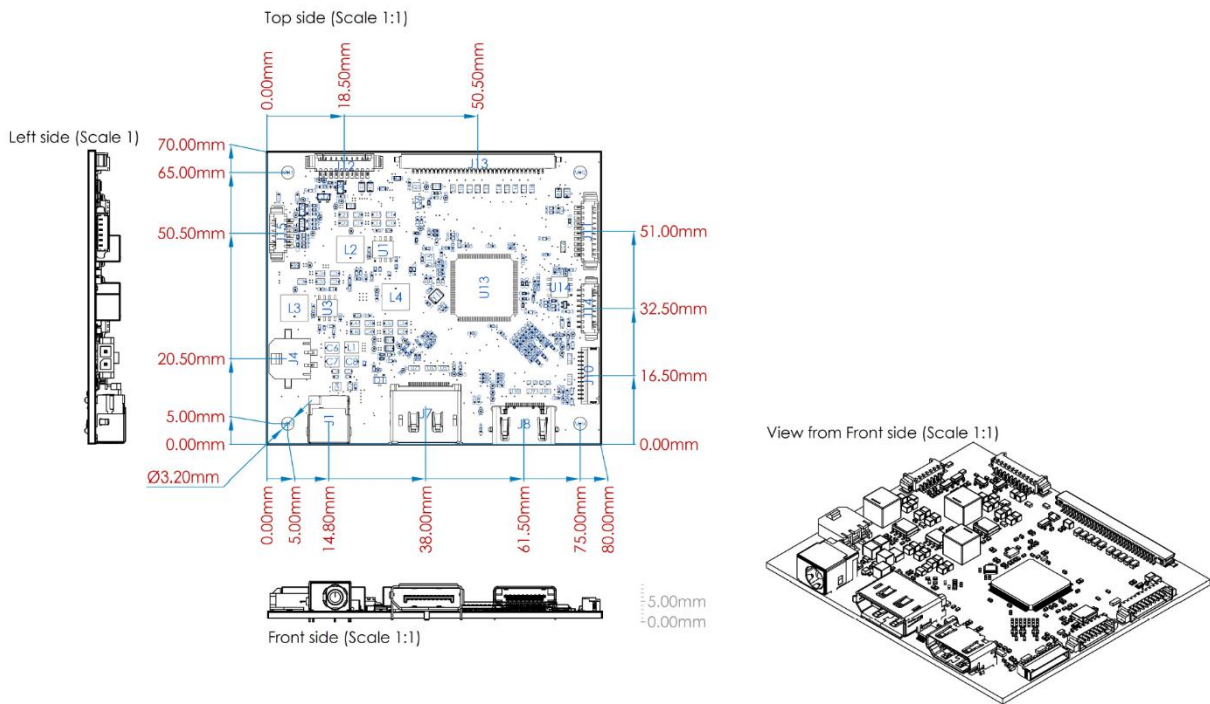

Fig 5. Outline

9. Connectors

Abbreviations used within this chapter are listed in the table below.

Table 22. Signal Assignment Abbreviations

Abbreviation	Description
GND	Ground
PWR	Power
I	Input
O	Output
I/O	Bi-directional
n.c.	Not connected (do not connect)

a. Connector Overview

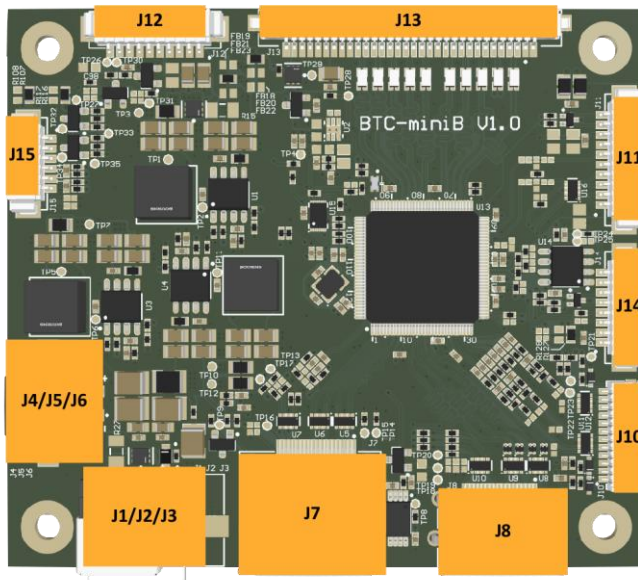

Fig 6. Connector Overview

b. Input Connectors

Power Connectors

The board offers different connector configurations to be supplied with power. In standard configuration, Power Connector (J1) and Power Connector (J4) are assembled. The other types and combinations are available on request.

Power Connector (J1)

The Power Connector (J1) supplies the board with power. The connection is mandatory.

Table 23. Power Connector (J1)

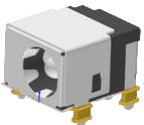
	Parameter	Value
	Manufacturer: Connector model no.	CUI Devices: PJ-079BH ¹⁰
	Pin amount	2 pins
	Mating housing part	DC Jack 2.5mm x 5.5mm

Note: 5A max

Table 24. Power Connector (J1) Pin Assignment

Pin	Signal	Description	Type
Inner	VIN	Power input	PWR
Outer	GND	Ground	GND

Power Connector (J2)

The Power Connector (J2) supplies the board with power. The connection is mandatory.

Table 25. Power Connector (J2)

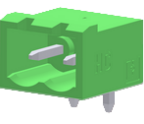
	Parameter	Value
	Manufacturer: Connector model no.	Phoenix Contact: 1923759
	Pin amount	2 pins (use Pin 1 as marked on connector)
	Mating housing part	Phoenix Contact: 1911855

Note: 16A max

Table 26. Power Connector (J2) Pin Assignment

Pin	Signal	Description	Type
1	GND	Ground	GND
2	VIN	Power input	PWR

Power Connector (J3)

The Power Connector (J3) supplies the board with power. The connection is mandatory.

Table 27. Power Connector (J3)

Parameter	Value

¹⁰ Mechanically highest part in var. STD

	Manufacturer: Connector model no.	Molex: 43650-0212
	Pin amount	2 pins (use Pin 1 as marked on connector)
	Mating housing part	Molex: 43645-0200

Note: 8.5A max

Table 28. Power Connector (J3) Pin Assignment

Pin	Signal	Description	Type
1	GND	Ground	GND
2	VIN	Power input	PWR

Power Connector (J4)

The Power Connector (J4) supplies the board with power. The connection is mandatory.

Table 29. Power Connector (J4)

	Parameter	Value
	Manufacturer: Connector model no.	Molex: 43650-0212
	Pin amount	2 pins (use Pin 1 as marked on connector)
	Mating housing part	Molex: 43645-0200

Note: 8.5A max

Table 30. Power Connector (J4) Pin Assignment

Pin	Signal	Description	Type
1	GND	Ground	GND
2	VIN	Power input	PWR

Power Connector (J5)

The Power Connector (J5) supplies the board with power. The connection is mandatory.

Table 31. Power Connector (J5)

	Parameter	Value
	Manufacturer: Connector model no.	Molex: 43650-0225
	Pin amount	2 pins (use Pin 1 as marked on connector)
	Mating housing part	Molex: 43645-0200

Note: 8.5A max

Table 32. Power Connector (J5) Pin Assignment

Pin	Signal	Description	Type
1	GND	Ground	GND
2	VIN	Power input	PWR

Power Connector (J6)

The Power Connector (J6) supplies the board with power. The connection is mandatory.

Table 33. Power Connector (J6)

	Parameter	Value
	Manufacturer: Connector model no.	Phoenix contact: 1727010-02
	Pin amount	2 pins (use Pin 1 as marked on PCB)
	Mating housing part	Conductor 1.5mm ² / AWG26

Note: 13.5A max

Table 34. Power Connector (J6) Pin Assignment

Pin	Signal	Description	Type
1	VIN	Power input	PWR
2	GND	Ground	GND

Video Input

The board has different connectors to connect a source, which provides the video signal. In standard configuration all video connectors are assembled.

DisplayPort Connector (J7)

The DisplayPort Connector (J7) can be used to provide a digital video signal to the board. The connection is mandatory.

Table 35. DisplayPort Connector (J7)

	Parameter	Value
	Manufacturer: Connector model no.	Standard DisplayPort receptacle
	Pin amount	20 pins
	Mating housing part	Standard DisplayPort plug

Table 36. DisplayPort Connector (J7) Pin Assignment

Pin	Signal	Description	Type
1	ML_Lane 3 (n)	Main-Link lane 3-	I
2	GND	Ground	GND
3	ML_Lane 3 (p)	Main-Link lane 3+	I
4	ML_Lane 2 (n)	Main-Link lane 2-	I
5	GND	Ground	GND
6	ML_Lane 2 (p)	Main-Link lane 2+	I
7	ML_Lane 1 (n)	Main-Link lane 1-	I
8	GND	Ground	GND
9	ML_Lane 1 (p)	Main-Link lane 1+	I
10	ML_Lane 0 (n)	Main-Link lane 0-	I
11	GND	Ground	GND
12	ML_Lane 0 (p)	Main-Link lane 0+	I
13	Config 1	-	-
14	Config 2	-	-
15	AUX CH (p)	AUX-CH+	I/O
16	GND	Ground	GND

17	AUX CH (n)	AUX-CH-	I/O
18	HPD	Hot-plug detect	0
19	PWR Return (GND)	Ground	GND
20	PWR (3.3V)	Power	PWR

HDMI connector (J8)

The HDMI connector (J8) can be used to provide a digital video signal to the board. The connection is mandatory.

Table 37. HDMI connector (J8)

	Parameter	Value
	Manufacturer: Connector model no.	Standard HDMI Type A (Single Link) receptacle
	Pin amount	19 pins
	Mating housing part	Standard HDMI Type A (Single Link) plug

Note: HDMI receptacle with flange available.

Table 38. HDMI connector (J8) Pin Assignment

Pin	Signal	Description	Type
1	D2+	T.M.D.S. Data2+	I
2	GND	T.M.D.S. Data2 shield	GND
3	D2-	T.M.D.S. Data2-	I
4	D1+	T.M.D.S. Data1+	I
5	GND	T.M.D.S. Data1 shield	GND
6	D1-	T.M.D.S. Data1-	I
7	D0+	T.M.D.S. Data0+	I
8	GND	T.M.D.S. Data0 shield	GND
9	D0-	T.M.D.S. Data0-	I
10	RXC+	T.M.D.S. Clock+	I
11	GND	T.M.D.S. Clock shield	GND
12	RXC-	T.M.D.S. Clock-	I
13	n.c.	-	n.c.
14	n.c.	-	n.c.
15	SCL	DDC Clock	I/O
16	SDA	DDC Data	I/O
17	GND	DDC/CEC Ground	GND
18	VCC	+5V Power	PWR
19	HPD	Hot-plug detect	0

RGB connector (J10)

The RGB connector (J10) can be used to provide an analog RGB signal to the board. The connection is mandatory.

Table 39. RGB connector (J10)

	Parameter	Value
	Manufacturer: Connector model no.	CviLux: C11412M1HRL-NH
	Pin amount	12 pins (use Pin 1 as marked on connector)
	Mating housing part	CviLux: C11412SL000-NH

Table 40. RGB connector (J10) Pin Assignment

Pin	Signal	Description	Type
1	AVS	Vertical sync	I
2	AHS	Horizontal sync	I
3	GND	Ground	GND
4	B- / Pb-	Blue ground / Pb-	I
5	B+ / Pb+	Blue signal / Pb+	I
6	G- / Y-	Green ground / Y-	I
7	G+ / Y+	Green signal / Y+	I
8	R- / Pr-	Red ground / Pr-	I
9	R+ / Pr+	Red signal / Pr+	I
10	GND	Ground	GND
11	SCL	DDC clock	I/O
12	SDA	DDC data	I/O

OSD Interface Connector (J15)

The OSD Interface Connector (J15) can be used for different purposes. An OSD-keyboard can be connected by this interface. The connection is optional.

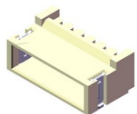
Table 41. OSD Interface Connector (J15)

	Parameter	Value
	Manufacturer: Connector model no.	Molex: 53261-0671
	Pin amount	6 pins (use Pin 1 as marked on connector)
	Mating housing part	Molex: 51021-0600

Note: Max 1A per contact

Table 42. OSD Interface Connector (J15) Pin Assignment

Pin	Signal	Description	Type
1	LED_GN	LED Green	O
2	LED_RD	LED Red	O
3	KEY1	Keypad Input 1	I
4	KEY2	Keypad Input 2	I
5	GND	Ground	GND
6	3.3V	Power	O

c. Output Connectors

LVDS Interface (J13)

The LVDS Interface (J13) is the video output interface. The connection is mandatory.

Table 43. LVDS Interface (J13)

	Parameter	Value
	Manufacturer: Connector model no.	JAE: FI-X30SSLA-HF
	Pin amount	30 pins (use Pin 1 as marked on connector)
	Mating housing part	JAE: FI-X30HL

Note: Max 1A per contact

Table 44. LVDS Interface (J13) Pin Assignment

Pin	Signal	Description	Type
1	GND	Ground	GND
2	TXE3+	Positive LVDS differential data output – Line 3 (even)	0
3	TXE3-	Negative LVDS differential data output – Line 3 (even)	0
4	TXECLK+	Positive LVDS differential data output (even)	0
5	TXECLK-	Negative LVDS differential data output (even)	0
6	TXE2+	Positive LVDS differential data output – Line 2 (even)	0
7	TXE2-	Negative LVDS differential data output – Line 2 (even)	0
8	TXE1+	Positive LVDS differential data output – Line 1 (even)	0
9	TXE1-	Negative LVDS differential data output – Line 1 (even)	0
10	TXE0+	Positive LVDS differential data output – Line 0 (even)	0
11	TXE0-	Negative LVDS differential data output – Line 0 (even)	0
12	GND	Ground	GND
13	TXO3+	Positive LVDS differential data output – Line 3 (odd)	0
14	TXO3-	Negative LVDS differential data output – Line 3 (odd)	0
15	TXOCLK+	Positive LVDS differential clock output (odd)	0
16	TXOCLK-	Negative LVDS differential clock output (odd)	0
17	TXO2+	Positive LVDS differential data output – Line 2 (odd)	0
18	TXO2-	Negative LVDS differential data output – Line 2 (odd)	0
19	TXO1+	Positive LVDS differential data output – Line 1 (odd)	0
20	TXO1-	Negative LVDS differential data output – Line 1 (odd)	0
21	TXO0+	Positive LVDS differential data output – Line 0 (odd)	0
22	TXO0-	Negative LVDS differential data output – Line 0 (odd)	0
23	GND	Ground	GND
24	GND	Ground	GND
25	GND	Ground	GND
26	V_PNL	Panel Power	0
27	V_PNL	Panel Power	0
28	V_PNL	Panel Power	0
29	V_PNL	Panel Power	0
30	V_PNL	Panel Power	0

Backlight Connector (J12)

The Backlight Connector (J12) is used to power backlight units. The connection is mandatory.

Table 45. Backlight Connector (J12)

	Parameter	Value
	Manufacturer: Connector model no.	Molex: 53261-1071
	Pin amount	10 pins (use Pin 1 as marked on connector)
	Mating housing part	Molex: 51021-1000

Note: Max 1A per contact

Table 46. Backlight Connector (J12) Pin Assignment

Pin	Signal	Description	Type
1	V_BKL	Backlight Power	0
2	V_BKL	Backlight Power	0
3	V_BKL	Backlight Power	0
4	V_BKL	Backlight Power	0
5	GND	Ground	GND
6	GND	Ground	GND
7	GND	Ground	GND
8	GND	Ground	GND
9	BKL_EN	Backlight Enable	0
10	BKL_ADJ	Backlight Adjust	0

GPIO Connector (J14)

The GPIO Connector (J14) is used to attach external peripherals. The connection is optional.

Table 47. GPIO Connector (J14)

	Parameter	Value
	Manufacturer: Connector model no.	Molex: 53261-0871
	Pin amount	8 pins (use Pin 1 as marked on connector)
	Mating housing part	Molex: 51021-0800

Note: Max 1A per contact

Table 48. GPIO Connector (J14) Pin Assignment

Pin	Signal	Description	Type
1	V_OUT	Output Voltage (Typ. 3.3V)	0
2	GND	Ground	GND
3	ADC1 / GPIO	Analog to digital converter	I/O
4	ADC2 / GPIO	Analog to digital converter	I/O
5	SCL / RX / GPIO	I2C Clock / UART Receive / GPIO	I/O
6	SDA / TX / GPIO	I2C Data / UART Transmit / GPIO	I/O
7	PWM1 / GPIO	Pulse Width Modulation Output / GPIO	I/O
8	PWM2 / GPIO	Pulse Width Modulation Output / GPIO	I/O

Audio Connector (J11)

The Audio Connector (J11) can be used to attach external audio periphery. A DAC might be connected by I²S. The connection is optional.

Table 49. Audio Connector (J11)

	Parameter	Value
	Manufacturer: Connector model no.	Molex: 53261-1071
	Pin amount	10 pins (use Pin 1 as marked on connector)
	Mating housing part	Molex: 51021-1000

Note: Max 1A per contact

Table 50. Audio Connector (J11) Pin Assignment

Pin	Signal	Description	Type
1	MCK	Master Clock	O
2	SCK	Serial Clock	O
3	WS	Word Select	O
4	SD0 / SPDIF0 / SOUT_L	Serial Data / SPDIFOUT	O
5	GND	Ground	GND
6	SOUT_R	Speaker out right	O
7	GND	Ground	GND
8	V_OUT	Output Voltage (Typ. 3.3V)	O
9	SCL	I2C Clock	I/O
10	SDA	I2C Data	I/O

10. Environmental Ratings

Table 51. Environmental ratings

Symbol	Test item	Min	Max	Unit
ϑ_{ST}	Storage temperature	-20	70	°C
ϑ_{OP}	Operating temperature ¹¹	0	60	°C

11. Absolute Maximum Ratings

Table 52. Absolute maximum ratings

Symbol	Test item	Min	Max	Unit
ϑ_{ST}	Storage temperature	-35	70	°C
ϑ_{OP}	Operating temperature	-10	65	°C

12. Application Information

a. Operating Precautions

- Be sure to ground yourself before handling the controller board.
- Turn off power supply before inserting or disconnecting any connector.
- Spike noise causes maloperation of circuits. It should be lower than following voltage: $\pm 200\text{mV}$ (over and under shoot voltage).
- This module has high frequency circuits. Sufficient suppression to the electromagnetic interference shall be done by system manufacturers. Grounding and shielding methods may be important to minimize the interference.

b. General Cautions

- The responsibility for the applicability of customer specific products and use in a particular customer design is always within the authority of the customer.
- An important factor for each system integration is the thermal design. System designers might need to implement a passive or active cooling system in their specific design to keep the temperatures of all parts within the specification.
- Be careful of condensation at sudden temperature change. Condensation damages electrical contacted parts.
- When preparing a cable for a specific display, always refer to appropriate cable pin-out and display specification. Always check the signals before connecting the cable. Any incorrect pin connection may

¹¹ Phase- or clock-shift can appear between -10°C and 0°C

damage the display and the controller permanently.

- Take care of all the sensitive electronic components.
- Do not modify the module assembly.
- You must mount a module using its respective mounting holes and avoid any bend force during mounting.
- Be sure to check the board's status LED and do a reset in OSD if any problem occurs during operation.
- Should you need any technical help, please contact Beck GmbH & Co. Elektronik Bauelemente KG.

c. Status LED

BTC-miniB has an on-board LED which can be used to check the board's status without a display attached. More detailed information will be printed as on-screen-message on the display (if attached). LED colors and their meanings are described in the table below.

Table 53. On-board LED status table

LED Color	Represents	User Actions
Off	Incorrect power supply	Check power supply
Green	Normal state	n/a
Red	Input signal/cable error	Check cable and input signal

13. Ordering Information

This board is available in different configurations which can be selected as best suitable for your application. The predefined hardware configurations of are available. If another assembly configuration or special FW settings (e.g. default values, boot logo, etc.) suits your needs better, please contact Beck GmbH & Co. Elektronik Bauelemente KG for a customized configuration.

Table 54. Variant selection table

#	Var.	V _{IN}	DisplayPort	HDMI	Analog RGB	Reverse voltage protection	GPIOs	Audio
1	STD	12V / 18V-32V	✓	✓	✓	✓	✓	✓
2	Lite, 24V	18V-32V	✓	✓	✗	✗	✗	✗
3	Lite, 12V	12V	✓	✓	✗	✗	✗	✗

14. Packaging / Labels

a. Part

Serial number

Serial number looks in general the following way:

AAANNYYMMDDXXXX

Table 55. S/N Encoding

Code	Meaning
AAA	Acronym for the SMT producer
NN	Firmware version
YYMMDD	Manufacturing date (YY-MM-DD)
XXXX	Manufacturing sequence of product

Label

Part label will look similar to the figure below.

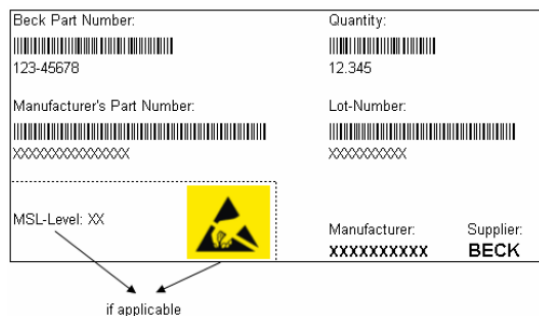

Fig 7. Part label

ESD bag

Each board will be packed in a conductive ESD bag.

b. Packaging

Label

The outer label will be similar to the figure below.

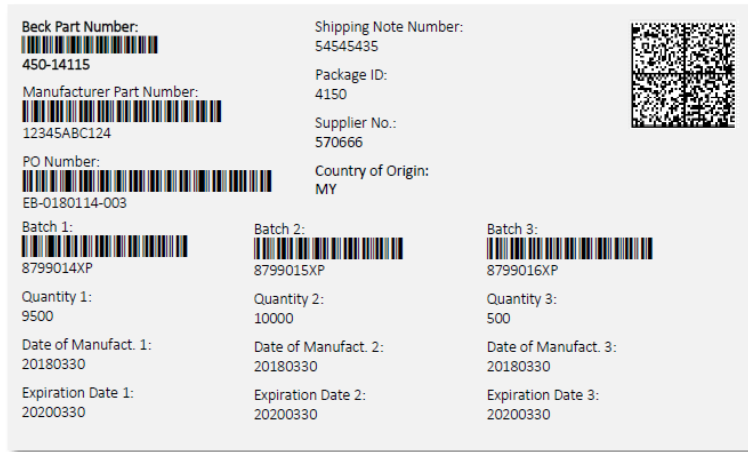

Fig 8. Box label

Box

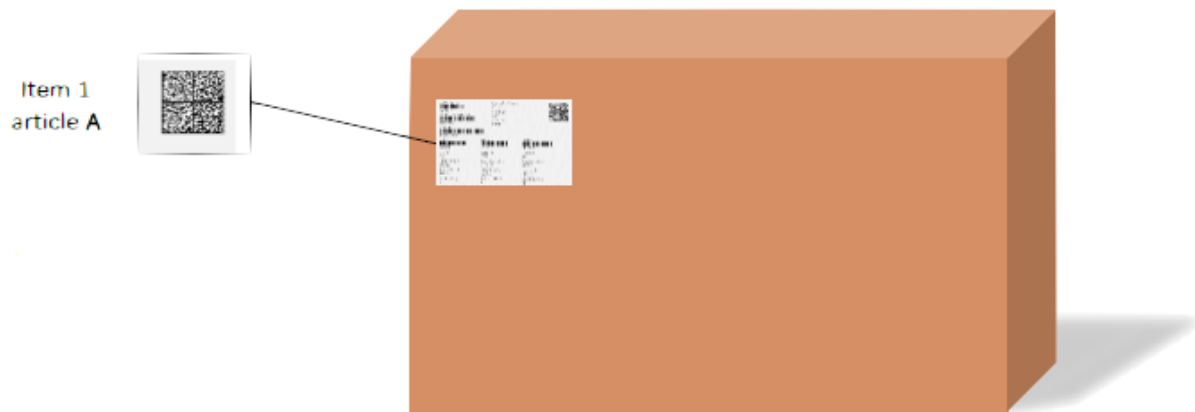

Fig 9. Carton

Table 56. Packaging details

Name	Value
Max capacity	360 pcs per carton
Max. weight	14.0 kg per carton
Outline dimension of carton	530 mm x 350 mm x 300 mm

15. Abbreviations

Table 57. Abbreviations

Abbr.	Description
ALS	Ambient Light Sensor
BLU	Backlight Unit
BPC	Bits Per Color
BPP	Bits Per Pixel
DAC	Digital-to-analog Converter
DDC	Display Data Channel
DDC/CI	Display Data Channel Command Interface
DDWG	Digital Display Working Group
DPLL	Digital Phase-Locked Loop
DPMS	Display Power Management Service
EDID	Extended Display Identification Data
EEPROM	Electrically Erasable Programmable Read-Only Memory
EMI	Electromagnetic Interference
ESD	Electrostatic Discharge
GND	Ground
HDCP	High Digital Content Protection
HDMI	High Definition Multimedia Interface
I²C	Inter Integrated Circuit
I²S	Inter-IC Sound
ISP	In System Programming
JEIDA	Japan Electronic Industry Development Association
LCD	Liquid Crystal Display
LED	Light Emitting Diode
LVDS	Low Voltage Different Signaling
MCCS	Monitor Command Control Set
OSD	On Screen Display
PCB	Printed Circuit Board
PCLK	Pixel Clock

PWM	Pulse Width Modulation
REACH	Registration, Evaluation, Authorization and Restriction of Chemicals
RGB	Red, Green, Blue
RoHS	Restriction of Hazardous Substances
SMBus	System Management Bus
SMT	Surface Mounted Technology
SOG	Sync-On-Green
sRGB	Standard-RGB
TMDS	Transition-Minimized Different Signaling
TFT	Thin-Film Transistor
VCP	Virtual Control Panel
VESA	Video Electronics Standards Association

16. Revision History

Table 58. Revision History

Rev.	Date	Section	Specification Status	Description
-	Jun 20 th , 2022	All	Final	Initial release

17. Legal Information

a. Disclaimers

Limited warranty and liability

Information in this document is believed to be accurate and reliable. However, Beck GmbH & Co. Elektronik Bauelemente KG does not give any representations or warranties, expressed or implied, as to the accuracy or completeness of such information.

Unless Beck has explicitly designated an individual product as meeting the requirements of a particular industry standard, Beck is not responsible for any failure to meet such industry standard requirements.

Buyers should obtain the latest relevant information before placing orders and should verify that such information is current and complete.

Right to make changes

Beck GmbH & Co. Elektronik Bauelemente KG reserves the right to make corrections, enhancements, improvements and other changes to its products and services and to discontinue any product or service, including without limitation specifications and product descriptions, at any time and without notice. This document supersedes all information supplied prior to the publication hereof.

Applications

Applications that are described herein are for illustrative purposes only. Beck GmbH & Co. Elektronik Bauelemente KG makes no representation or warranty that such applications will be suitable for the specified use without further testing or modification.

The customer is responsible for the design and operation of his application. It is the customer's responsibility to determine whether this product is suitable for his applications and products.

Limiting values

Stress above one or more limiting values (as defined in section Absolute maximum ratings) may cause permanent damage and irreversibly affect the quality and reliability of the device.

b. Trademarks

All referenced brands, product names, service names and trademarks are the property of their respective owners.

18. Tables

TABLE 1. ELECTRICAL INPUT CHARACTERISTICS	6	TABLE 32. POWER CONNECTOR (J5) PIN ASSIGNMENT	17
TABLE 2. ELECTRICAL OUTPUT CHARACTERISTICS	6	TABLE 33. POWER CONNECTOR (J6)	18
TABLE 3. OSD KEYBOARD FUNCTIONS.....	7	TABLE 34. POWER CONNECTOR (J6) PIN ASSIGNMENT	18
TABLE 4. OSD-KEYBOARD LED STATUS LIGHTS.....	8	TABLE 35. DISPLAYPORT CONNECTOR (J7)	18
TABLE 5. OSD: MENU ITEMS.....	9	TABLE 36. DISPLAYPORT CONNECTOR (J7) PIN ASSIGNMENT	18
TABLE 6. OSD: MAIN-MENU PICTURE	9	TABLE 37. HDMI CONNECTOR (J8)	19
TABLE 7. OSD: MAIN-MENU DISPLAY	9	TABLE 38. HDMI CONNECTOR (J8) PIN ASSIGNMENT	19
TABLE 8. OSD: MAIN-MENU COLOR	9	TABLE 39. RGB CONNECTOR (J10)	19
TABLE 9. OSD: SUB-MENU: TEMPERATURE - USER.....	9	TABLE 40. RGB CONNECTOR (J10) PIN ASSIGNMENT	20
TABLE 10. OSD: SUB-MENU: COLOR EFFECT - USER	10	TABLE 41. OSD INTERFACE CONNECTOR (J15)	20
TABLE 11. OSD: MAIN-MENU ADVANCE	10	TABLE 42. OSD INTERFACE CONNECTOR (J15) PIN ASSIGNMENT	20
TABLE 12. OSD: MAIN-MENU INPUT.....	10	TABLE 43. LVDS INTERFACE (J13)	21
TABLE 13. OSD: MAIN-MENU AUDIO	10	TABLE 44. LVDS INTERFACE (J13) PIN ASSIGNMENT	21
TABLE 14. OSD: MAIN-MENU OTHER.....	10	TABLE 45. BACKLIGHT CONNECTOR (J12).....	22
TABLE 15. OSD: MAIN-MENU INFORMATION.....	10	TABLE 46. BACKLIGHT CONNECTOR (J12) PIN ASSIGNMENT	22
TABLE 16. LVDS BIT NUMBER MAPPINGS.....	11	TABLE 47. GPIO CONNECTOR (J14).....	22
TABLE 17. VESA DATA PACKING.....	11	TABLE 48. GPIO CONNECTOR (J14) PIN ASSIGNMENT....	22
TABLE 18. JEIDA DATA PACKING	11	TABLE 49. AUDIO CONNECTOR (J11)	23
TABLE 19. I ² C INTERFACE DC CHARACTERISTICS	12	TABLE 50. AUDIO CONNECTOR (J11) PIN ASSIGNMENT ...	23
TABLE 20. I ² C INTERFACE AC CHARACTERISTICS	12	TABLE 51. ENVIRONMENTAL RATINGS	24
TABLE 21. MECHANICAL CHARACTERISTICS.....	14	TABLE 52. ABSOLUTE MAXIMUM RATINGS	24
TABLE 22. SIGNAL ASSIGNMENT ABBREVIATIONS.....	15	TABLE 53. ON-BOARD LED STATUS TABLE	25
TABLE 23. POWER CONNECTOR (J1)	16	TABLE 54. VARIANT SELECTION TABLE	25
TABLE 24. POWER CONNECTOR (J1) PIN ASSIGNMENT	16	TABLE 55. S/N ENCODING.....	26
TABLE 25. POWER CONNECTOR (J2)	16	TABLE 56. PACKAGING DETAILS	27
TABLE 26. POWER CONNECTOR (J2) PIN ASSIGNMENT	16	TABLE 57. ABBREVIATIONS	28
TABLE 27. POWER CONNECTOR (J3)	16	TABLE 58. REVISION HISTORY.....	30
TABLE 28. POWER CONNECTOR (J3) PIN ASSIGNMENT	17		
TABLE 29. POWER CONNECTOR (J4)	17		
TABLE 30. POWER CONNECTOR (J4) PIN ASSIGNMENT	17		
TABLE 31. POWER CONNECTOR (J5)	17		

19. Figures

FIG 1. SYSTEM DIAGRAM.....	4	FIG 6. CONNECTOR OVERVIEW	15
FIG 2. APPLICATION OF BTC-MINIB	5	FIG 7. PART LABEL	26
FIG 3. OSD-KEYBOARD	7	FIG 8. BOX LABEL	27
FIG 4. OSD-MENU STRUCTURE	8	FIG 9. CARTON.....	27
FIG 5. OUTLINE	14		

20. Contents

BTC-MINIB	1	c. OUTPUT CONNECTORS	21
(DISPLAYPORT, HDMI AND RGB TFT-LCD CONTROLLER)			
.....	1		
1. PRODUCT OVERVIEW	2	10. ENVIRONMENTAL RATINGS	24
2. FEATURES	2	11. ABSOLUTE MAXIMUM RATINGS	24
3. FUNCTIONAL DIAGRAM	4	12. APPLICATION INFORMATION	24
4. TYPICAL APPLICATION	5	A. OPERATING PRECAUTIONS	24
5. ELECTRICAL CHARACTERISTICS	6	B. GENERAL CAUTIONS	24
A. INPUT.....	6	C. STATUS LED	25
B. OUTPUT.....	6	13. ORDERING INFORMATION	25
6. OSD (ON-SCREEN DISPLAY)	7	14. PACKAGING / LABELS	26
A. OSD-KEYBOARD	7	A. PART.....	26
B. OSD-MENU.....	8	B. PACKAGING.....	26
7. INTERFACES	11	15. ABBREVIATIONS	28
A. LVDS INTERFACE.....	11	16. REVISION HISTORY	30
B. I ² C INTERFACE	12	17. LEGAL INFORMATION	30
C. I ² S INTERFACE.....	13	A. DISCLAIMERS.....	30
D. DDC.....	13	B. TRADEMARKS	30
8. MECHANICAL CHARACTERISTICS	14	18. TABLES	31
9. CONNECTORS	15	19. FIGURES	31
A. CONNECTOR OVERVIEW	15	20. CONTENTS	32
B. INPUT CONNECTORS	16	21. CONTACT INFORMATION	32

21. Contact Information

For more information or technical support, please visit: <https://www.beck-elektronik.de>